

PEGASUS[®] BT 4D

GC×GC-TOFMS



LECO
EMPOWERING RESULTS

Improve all parts of your analysis with GCxGC-TOFMS

- **Qualitative Power**

- The Pegasus BT 4D improves identification due to the increased chromatographic capabilities of GCxGC

- **Quantitative Power**

- The Pegasus BT 4D provides lower detection limits by increasing signal and reducing noise

With the Pegasus BT 4D you are able to perform qualitative and quantitative analysis all at once through a single run, which not only yields richer chemical data, but also gives you an overall increase in your laboratory's productivity and efficiency.



What Will GCxGC Do For You?

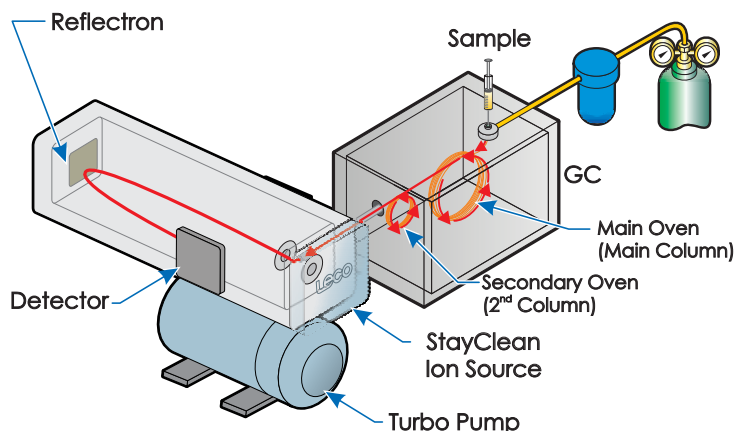

- Industry-leading sensitivity is improved with the addition of GCxGC, which enhances S/N and makes what was once unobserved a clearly identifiable analyte
- You'll be able to identify more compounds, more efficiently with the power of GCxGC separation
- The tried-and-tested reliability and durability of our StayClean® ion source eliminates the need for source cleaning, improving your productivity
- LECO's ChromaTOF® brand software works seamlessly with the Pegasus BT 4D to automatically process user data and remove the guesswork involved with analyte identification and quantification
- You'll know what to expect from your data, through the power of chemically structured chromatograms

Predict, Quantify, and Identify What Is In Your Sample

Excellent Identification 1

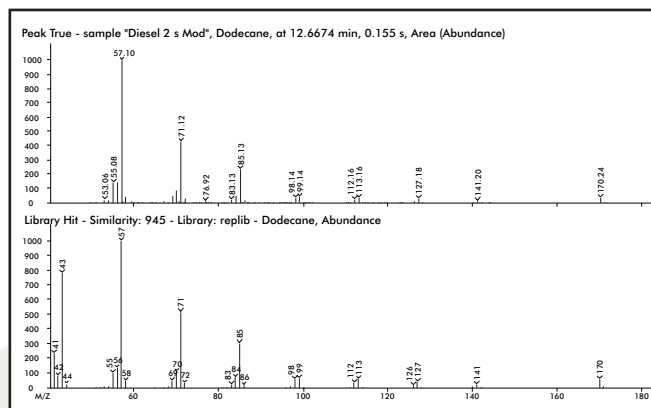

Excellent Identification 2

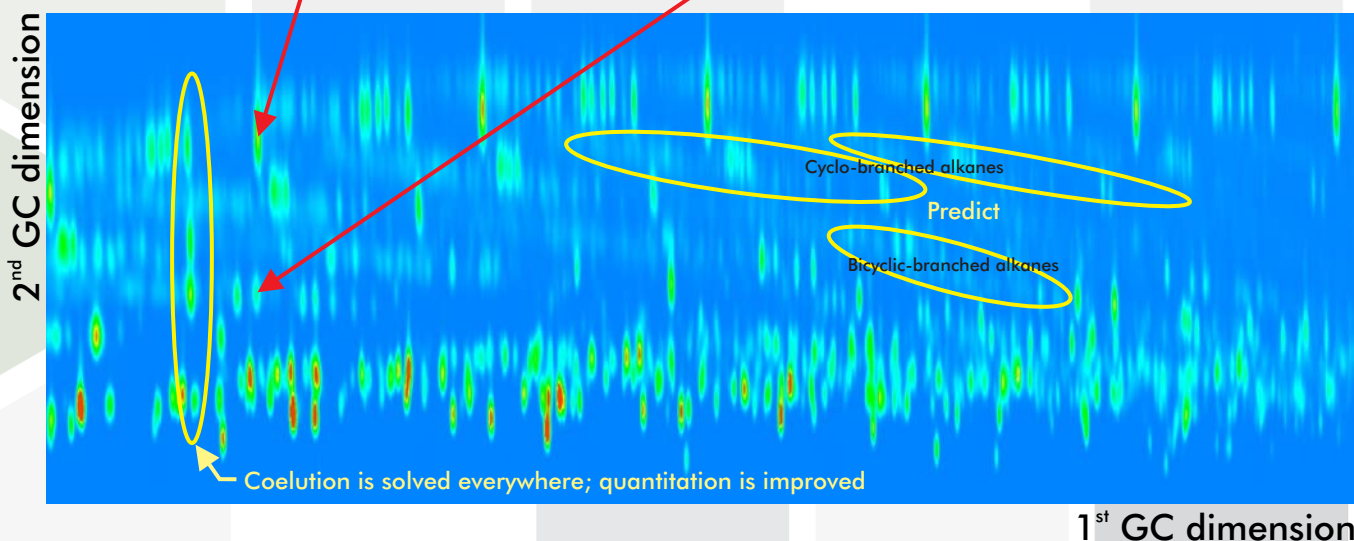
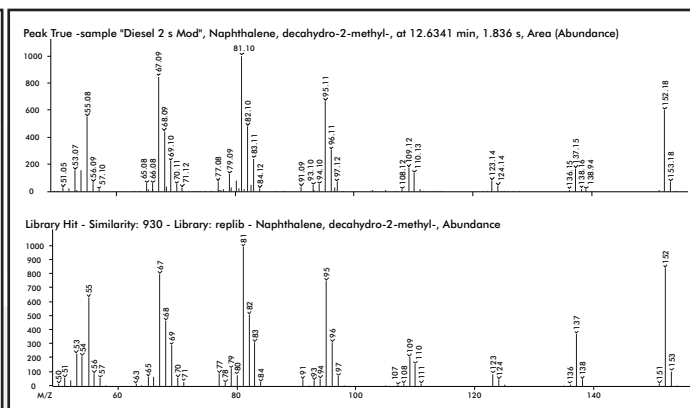

Quantitative Analysis Using the Pegasus BT 4D

By leveraging GCxGC's superior chromatographic resolution, you can often separate target analytes from matrix interferences or other target compounds. In the figure below, you can see the GC and GCxGC quantitation curves for Chloroneb. Thanks to the improvements from GCxGC peak focusing and chromatographic resolution, Chloroneb is separated from the nearby matrix interference. This results in dramatic improvements in overall sensitivity, linearity, and quantitation accuracy.

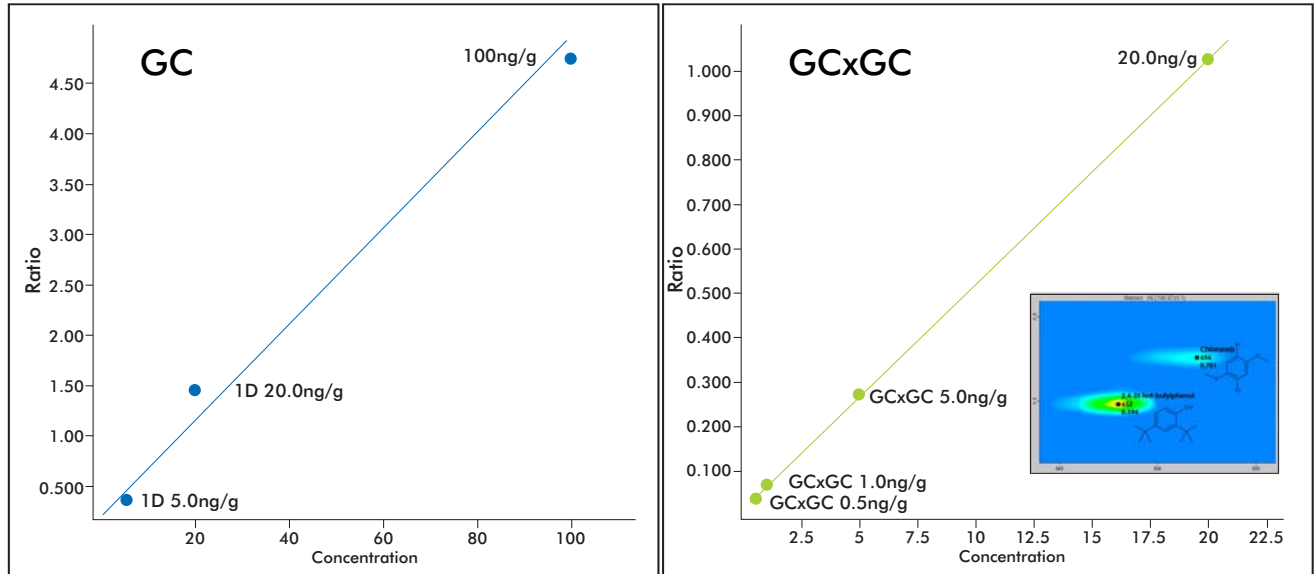

Qualitative Analysis Using the Pegasus BT 4D

Improve your identification—what was once a poor identification is now confidently confirmed.

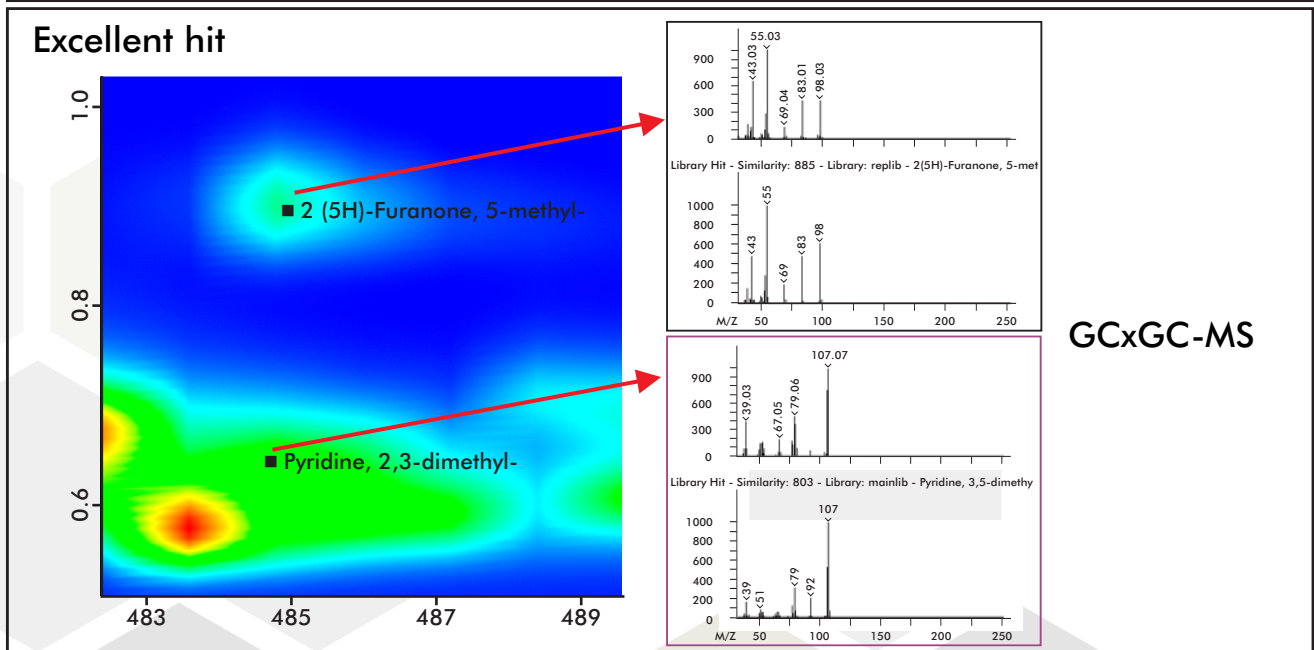
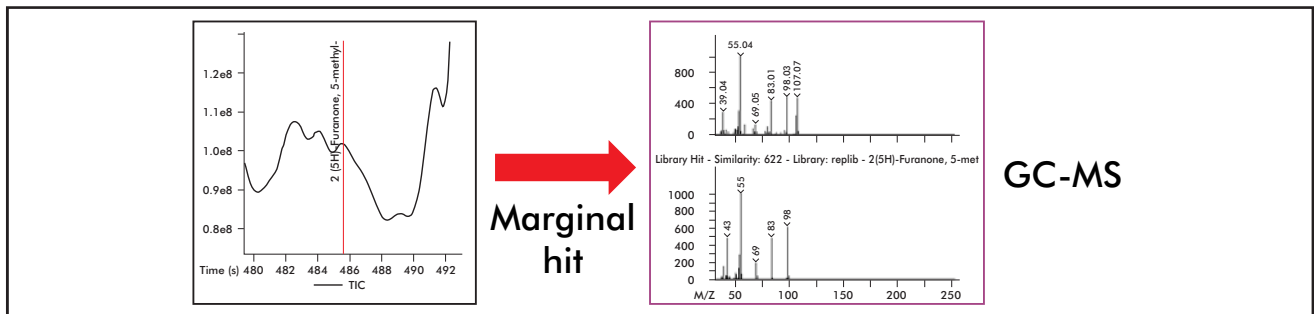

Excellent Sensitivity

The enhancement of S/N with the GCxGC modulation process makes what was once unobserved a clearly identifiable analyte in your sample.

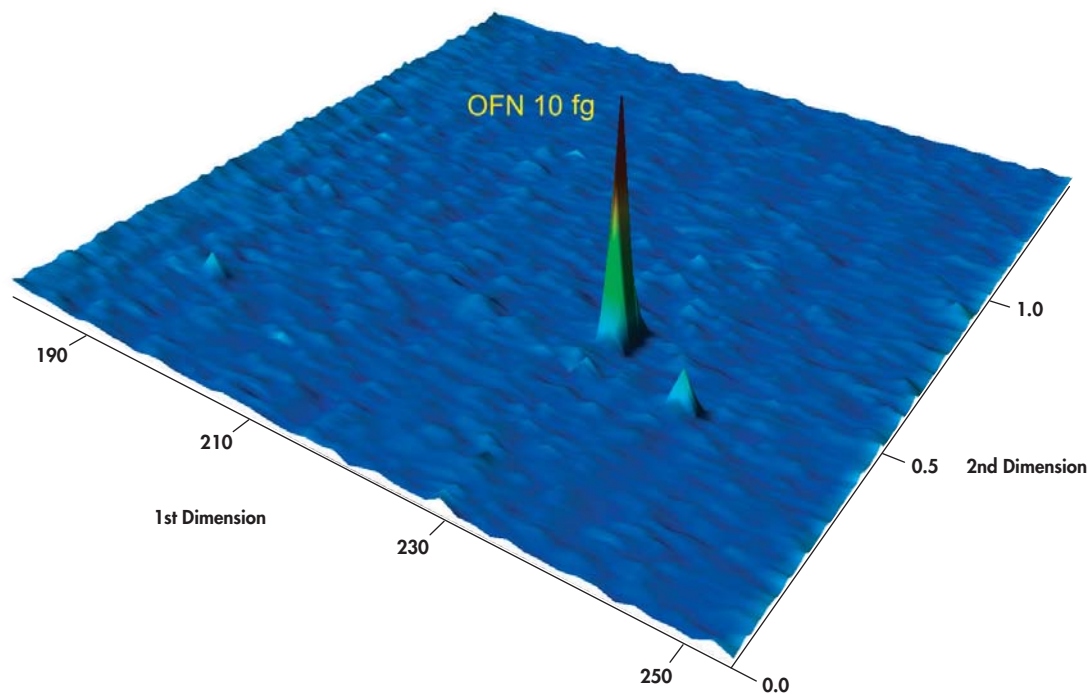

Identify MORE with Confidence/Non-Target Analysis

Smoker's Urine on the Pegasus BT 4D—GCxGC identifies more analytes; a few identified metabolites shown.

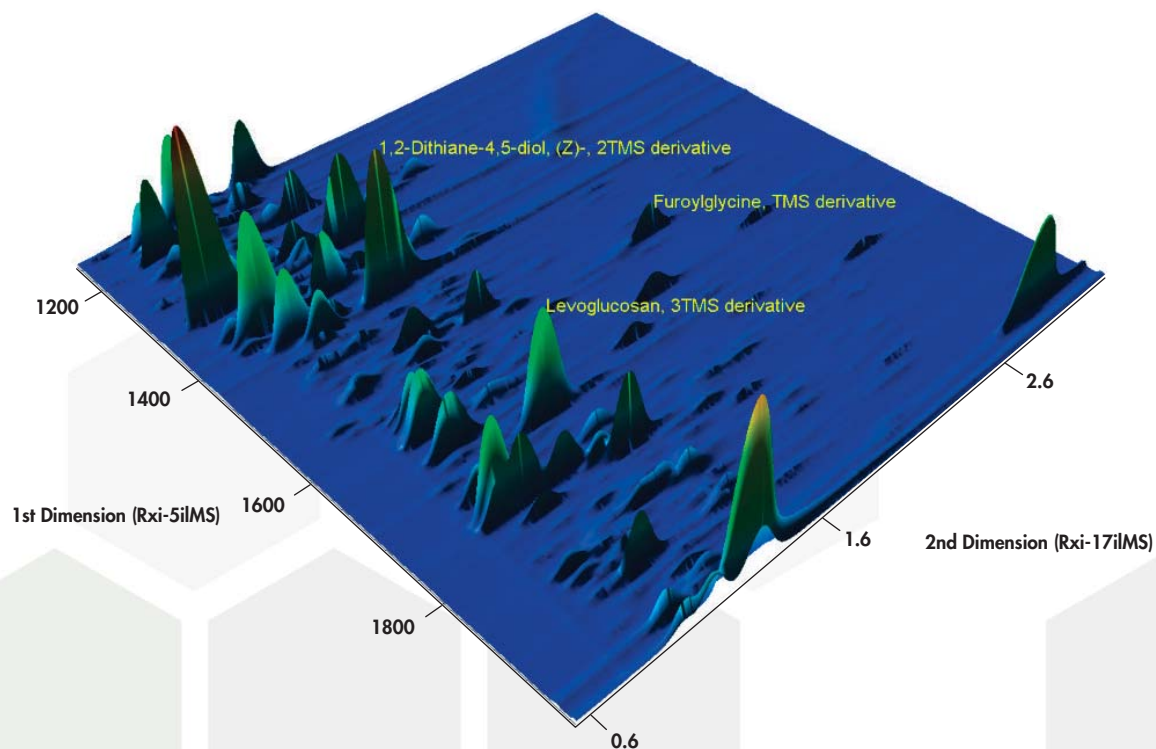

Flux™ Flow Modulator

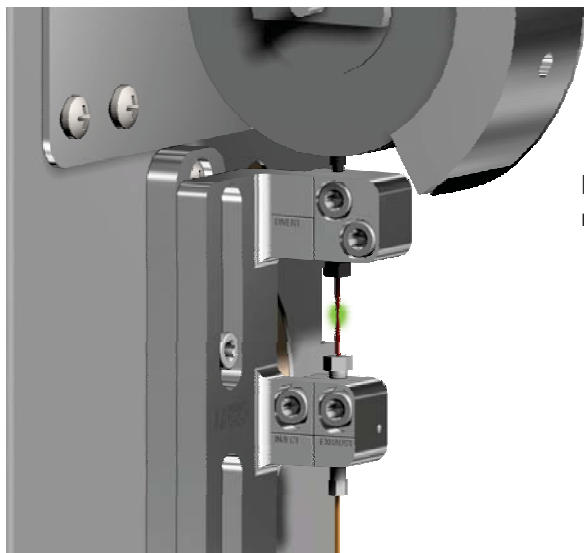

In addition to our highest performance quad-jet thermal modulation systems, we now have a diverting flow modulator.

- Excellent GCxGC performance
- No cryogenics or high flow rates needed
- Easy to setup, develop methods, and run—all in one day!
- See 209-275 for more details

LECO's Commitment to Quality and Service

Every day around the world, LECO instruments continuously perform analyses for today's most complex applications. Whether you are analyzing samples in the food, flavor/fragrance, petroleum, environmental, or life science (metabolomics) industries, we have an instrument configuration to meet your needs.



Technical Research Center



Customer Demonstration and Application Center

Our global network of sales/support includes over 25 subsidiaries worldwide, and is dedicated to customer service and satisfaction. Our commitment to quality is further underscored with ISO-9001:2015 certification. We conform to CE quality and safety specifications, fully testing instruments at our on-site Compliance Testing Center.

LECO
Simply GCxGC®

Our *Simply GCxGC* tool takes the worry out of GCxGC by guiding you step-by-step to maximize peak capacity. Learn more at <https://www.leco.com/simply-gcxc>

LECO, Pegasus, ChromaTOF, StayClean, NonTarget Deconvolution, NTD, Flux, and Simply GCxGC are trademarks of LECO Corporation.

3000 Lakeview Avenue | St. Joseph, MI 49085 | 800-292-6141 | Phone: 269-985-5496
info@leco.com | www.leco.com | ISO-9001:2015 Q-994 | LECO is a registered trademark of LECO Corporation.

LECO
EMPOWERING RESULTS